



Motor Mastery University



The AC's & DC's of Electric Motors

APPLICATION

INCLUDES:

BASIC PRINCIPLES

MOTOR CONSTRUCTION

AC INDUCTION MOTORS

SELECTING THE PROPER MOTOR

MOTOR REPLACEMENT

QUESTIONS & ANSWERS

REGAL

TABLE OF CONTENTS

BASIC PRINCIPLES

Magnetism	2
Characteristics	
Magnetic Materials	
Magnetic Field	
Electricity	2
Static Electricity	
Conductivity of Materials	
First Generator	
Electromagnet	
Induction	
Work, Power and Energy	4
Work Defined	
Horsepower Defined	
Watts Defined	
Watts per Horsepower Relationship	
Ohms Law—Tables and Formulas	
Energy Explained	
Alternating and Direct Current	5
Simple Circuit	
Where Power Comes From	
Distribution Systems	
Alternating Current Generator	
Cycles and Frequency	
Polyphase Power	

MOTOR CONSTRUCTION

Rotor and Stator	7
End Bells	7
Motor Mountings	8
Bearings	9
Sleeve	
Bearing Window	
Ball Bearings	
Comparison	
Insulation	9
Class A	
Class B	
Class F	
Class H	
Motor Enclosures	10
Name Plate	12

AC INDUCTION MOTORS

Series (Universal)	13
Path of Current Flow	
Uses	
Single Phase – Induction	13
Split Phase	
Starting Winding	
Running Winding	
Starting Switch	
Special Purpose Motors	
Capacitor Motors (Types)	
Capacitor Explained	
Electrical Connections	
Shaded Pole Motor	
Pole Construction	
Pole Shift Explanation	
Repulsion-Start Induction Motor	
Construction	
Short Circuiting Ring; Governor	
Polyphase – Induction	16
Explanation of 3-Phase Power	
Construction	
NEMA Dual Voltage Connections	
Star Connection	
Delta Connection	

SELECTING THE PROPER MOTOR

How to determine what motor to use	18
Available Power Supply	
Horsepower and Speed Requirements	
Best Motor for the Job	
Frame Size Needed	
Torque Considerations	
What Enclosure is Needed	
Bearing Type Required	
Direction of Rotation	
Motor Mounting	
Should Thermal Protection be Applied	
Typical speed torque curves	23
Small motor selection guide	24

MOTOR REPLACEMENT

Motor Replacement	28
Motor trouble chart	28

GLOSSARY, QUESTIONS	30-36
----------------------------------	-------

BASIC PRINCIPLES

MAGNETISM

Man's discovery of the phenomenon of magnetism is shrouded in mystery and ancient folklore.

Legend has it that a shepherd named Magnes, while tending his flock on the island of Crete, found his iron-tipped staff held to the ground by some invisible force. Digging just below the surface, he found a rock that exhibited this strange power of attraction.

This was a "lodestone"—a natural magnet—that we know now contained an oxide of iron. So, according to the legend, the city of Magnesia in Asia Minor took its name from this wandering shepherd, the ore in the rock was called "magnetite," and the natural phenomenon has ever since been called magnetism—all a legacy from Magnes.

For thousands of years, people believed that magnets had magic power to cure diseases, and to perform other remarkable feats. Today we know that the superstitions about magnets are not true because we have learned much more about magnets themselves. But we still cannot explain what the mysterious force called "magnetism" really is. We only know how it acts.

Magnets have certain important characteristics. They attract iron and some steel alloys. A magnet has a "north seeking" pole and a "south seeking" pole. This is why a compass indicates direction. The north-seeking point of the compass needle turns toward the earth's north pole.

The ancient Chinese were the first to capitalize on this principle in developing the first crude compass and by the time Columbus sailed from Spain in 1492, the compass was being used as an aid to navigation throughout the civilized world.

With magnets as with people, "opposites attract." The north pole of one magnet will cling to the south pole of another magnet, but two north poles placed near each other will tend to push the magnets apart.

Iron, steel, nickel and a few other materials can be magnetized. Because soft iron holds its magnetism only a short time, it is called a "temporary" magnet. On the other hand, steel holds its magnetism very well

and is used to make "permanent" magnets. Certain special alloys make magnets much more powerful than iron or steel. One of these is "alnico," which is a combination of iron, nickel and aluminum, and sometimes cobalt and copper.

There is a special "magnetic field" around every magnet. It is the area in which the magnet's pulling force is effective. The greatest "pull" or "attraction" is at the two poles of the magnet, and there are invisible "lines of force," like sound waves, extending from one pole to the other. See Fig. 1. for a graphic example of this phenomenon. Here, the iron filings line up just like the lines of force that exist between the two poles of the magnet. Later on we will find out why a magnet is necessary in a motor.

FIGURE 1

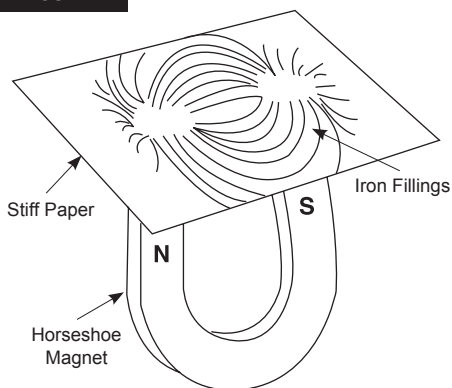

ELECTRICITY

Like magnetism, electricity is a form of energy but, although we have learned a great deal about how it works, we can't define it completely yet.

Electricity got its name in 1600 when Sir William Gilbert, personal physician to Queen Elizabeth I of England, coined the new word from "electron," the Greek word for amber. Amber is a hard yellowish to brownish translucent fossil resin chiefly used for ornamental purposes—but it was the first substance in which electricity had been observed.

Electricity can be either "static" or "current." If it is stored and not moving, we

FIGURE 2

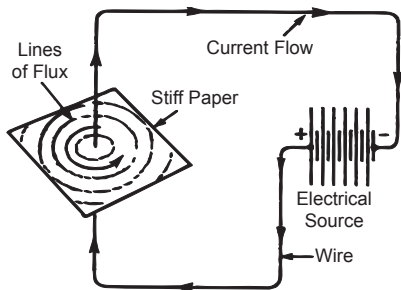
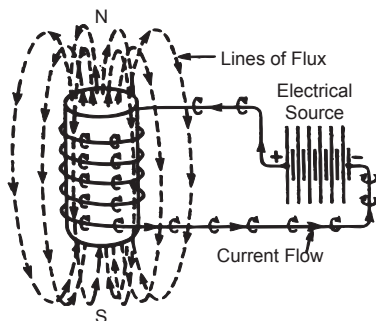

FIGURE 3



call it static electricity. A charge of this kind may be built up in certain substances by friction. If you walk briskly across a heavy carpet and then touch a metal railing, a light switch, or even shake hands with someone, you may get an unexpected "shock."

Some materials carry electric current better than others. Those that carry it well are called "conductors." All metals are fairly good conductors, but copper wire is most often used to conduct electricity.

Other materials that do not carry electricity well are called "non-conductors," or "insulators." Among these are paper, glass, wood and rubber. Many hotels place a large rubber mat in front of elevator doors to reduce or eliminate the static electricity which guests may build up by friction before they press the elevator button. Glass insulators are used on power lines, and rubber hand grips are often found on pliers and other tools. Light sockets are made of porcelain, another nonconductor, to prevent electric shocks.

The first evidence that electricity could be generated by machine came from a German named Otto von Guericke. In 1660, he built the first static electric generator, using a large ball of sulphur mounted on an axle. By rotating it and rubbing his dry hand on the surface, he found that the ball became charged sufficiently to attract pieces of paper, feathers, and other lightweight objects.

Benjamin Franklin, of kite, key and lightning fame, believed that electricity existed in either a positive (plus) or negative (minus) state. His idea led to the discovery that in electric charges, as well as with magnets, unlikes attract and likes repel.

The theory that electricity could move or flow was proved in the late 1700's as a result of the experiments of Luigi Galvani. Another Italian scientist, Alessandro Volta, developed the first battery, which was called the "voltaic pile" in his honor. This battery provided a steady source of electricity.

In the 1820's a Danish scientist, Hans Christian Oersted, used a battery to prove that electricity can produce magnetism. (See Fig. 2) A short time later, Andre Ampere, a Frenchman, demonstrated that a coil of wire acts like a natural magnet when a current is sent through it. Furthermore, a piece of iron or steel placed inside the coil also becomes magnetized. (See Fig. 3) Try it yourself. Wind a piece of wire around and around a nail many times. Then connect the wire to a battery and you will have what is known as an electromagnetic coil. The nail will act as a magnet, but only while the current is on.

The experiments of the English scientist, Michael Faraday, eventually led to the development of the first electric power generator. From reading about the work of Oersted and Ampere, he knew that an electrical current passing through a coil of wire creates a magnetic field. Then, he asked himself, what would happen if a coil of wire were moved past a magnet? He answered his own question by proving that a current of electricity would be produced in the wire as it passed by the magnet. In other words, the magnet would "induce" a current in the wire.

And now that we have covered the most important facts about magnetism and electricity, we are ready to discuss how electric energy is measured and how it is used.

WORK, POWER AND ENERGY

A few basic terms are commonly used in discussing electricity and motors.

First of all, there is a "unit of work." This term means Force multiplied by Distance. For example, if you lift a 50-pound weight two feet, you have performed 100 foot-pounds of work. (See Fig. 4) The time required to lift it is not considered in figuring "units of work."

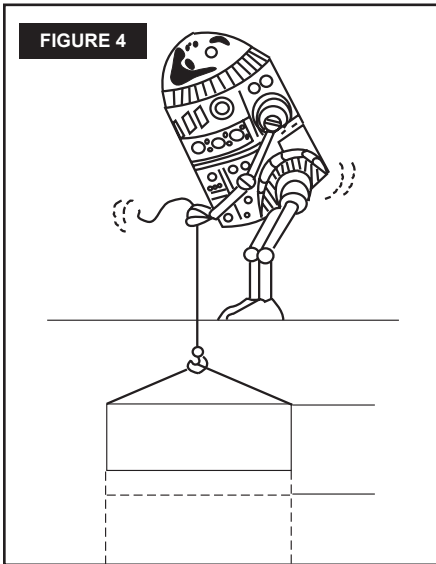

FIGURE 4

Torque is a force that tends to produce rotation. If a force of 50 pounds is applied to the handle of a 2' crank, this force produces 100 pounds of torque (twist-ability) when it is at right angles to the crank arm. Torque may be converted into horsepower when the element of time is considered. If the torque in foot pounds is measured over a given period of time—for example, one second or one minute—it becomes foot pounds per second or one minute, and may be converted into horsepower.

When torque, in foot pounds, is multiplied by the speed in revolutions per minute, it may be divided by the constant 5250 to find horsepower, using this formula

$$\text{Horsepower} = \frac{\text{Foot pounds torque} \times \text{revolution per minute}}{5250}$$

Horsepower has been the common measurement for mechanical power since the 1760's when an English scientist named James Watt proved that a horse hitched to a pulley could lift 550 pounds at the rate of one foot per second. He called this "one horsepower." In terms of a minute, one horsepower is the power required to lift 33,000 pounds one foot. A unit of power, then, is equal to a rate of 33,000 foot-pounds of work per minute, or 550 per second.

In his famous teakettle experiment, Watt also proved that steam power increases under pressure. The unit of electric power—a "watt"—was named after him. Electric pressure is called "voltage," for the Italian scientist, Volta. The quantity of electric current is known as "amperage," named for the Frenchman, Ampere.

FIGURE 5

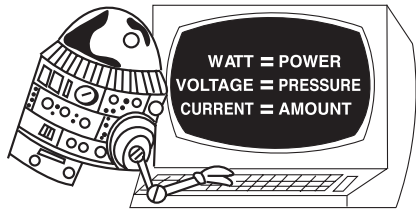

Current can have either high or low voltage. Direct current electric power in watts is figured by multiplying the number of volts by the number of amperes. All of us are familiar with the "wattage" of the electric light bulbs we used at home. However, electric power is usually expressed in 1000-watt units, or kilowatts. Incidentally, one horsepower is equal to 746 watts, or about 3/4 of one kilowatt.

Any conductor of electricity, such as a copper wire, offers a certain amount of resistance to the passage of electric current through it. The resistance is measured in ohms, named for the famous German scientist, George Ohm. One ohm is the amount of resistance in a wire through which a quantity of current equal to one ampere is flowing under one volt of electric pressure. Therefore, the amperage of a current can always be determined by dividing the voltage by the number of ohms of resistance in the conductor. This formula is known as Ohm's Law.

Energy has many forms and it can be changed from one form to another. Light bulbs, for example, convert electrical energy into light and heat.

The battery in your car stores up chemical energy which is converted into electrical energy when you turn on the starter. The starter then converts the electrical energy into mechanical energy to start the engine. The chemical energy of the gasoline is changed into mechanical energy by the engine, and this, in turn, is converted into electrical energy by the generator. The ignition coil converts the electrical energy from one voltage of amperage to a different voltage and amperage.

Energy is also converted by electric motors. They change electrical energy taken from power transmission lines into mechanical energy to do useful work like turning a water pump or powering a lathe.

But energy, horsepower, electricity and magnetism are only part of the fascinating story of motors. Before we find out more about basic motor principles and construction, however, we must know the difference between alternating current (AC) and direct current (DC).

FIGURE 6

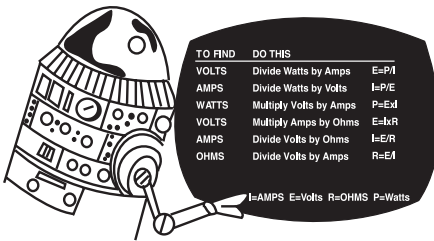

ALTERNATING CURRENT AND DIRECT CURRENT

Up to this point, we have learned about electricity, its units of measurement, and the fact that it can be put to work. However, there are a few other things about electric current that we must know before we can understand how the different types of electric motors operate.

The current discussed so far has been direct current, or DC. Batteries are the most

common source of DC current. When a battery is connected to a flashlight bulb by two wires, a path or circuit is provided for the current. The battery supplies the electrical force that causes current to move through one wire to the filament in the bulb and then through the second wire back to the battery. Since the current is flowing in only one direction, this type of current is called direct current or DC.

There is a second type of current produced by the motor called a generator. This type is called alternating current, or AC, because it flows back and forth in the wire. The electric power delivered to homes, offices, factories and hospitals is alternating current.

Each power company is responsible for the delivery of electric power in its own area. The company may be a small one, with only one or two diesel-driven generators, one control station for directing the flow of the power, and a few miles of wire strung on wooden poles. Or it may be a very large company covering an entire state, with generators in many locations driven by steam or water.

Power is delivered as inexpensively as possible by area control stations called power distribution boards. These boards control the different generators and electrical power lines through which power is supplied. The electric power you use may be “generated” hundreds of miles from your home. It travels along “high tension” lines to your neighborhood, where transformers change the high voltage to a lower voltage. Near your house is a transformer mounted on a pole. It further reduces the voltage to 115 volts or 230 volts which are the most common types of electric power. From this pole transformer, wires lead into your house to a fuse box or “circuit breaker” panel. Wires within the walls carry the power to the lights and electrical outlets in every room. Even though the voltage has been changed many times, the frequency of the alternating current has remained the same—60 cycles per second—ever since the current was produced by the generator, because the frequency of the generator’s power output is determined by the speed of the engine or turbine driving the generator shaft.

To better understand alternating current, we must remember an important principle

which was explained in a previous chapter— that when a wire is passing through a magnetic field, a flow of electric current is induced within it.

A generator uses this principle to produce electric power. It has a coil of wire mounted to its shaft so the coil will rotate between the poles of electromagnets mounted in the frame. As the coil moves toward the north magnetic pole, an electric current is produced in the wire. The strength of this current reaches its maximum point when the center of the coil is in line with the center of the north pole of the magnet. (See Fig. 7) Then it decreases, reaching zero when the coil is half way between the north and south magnetic poles. As the coil moves on toward the south pole, the current gradually increases again, but this time the direction of the current in the wire is reversed.

FIGURE 7

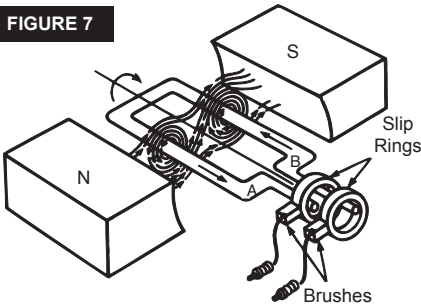

The continuing movement of the coil past the north and south poles of the magnet at high speed produces an electric current that changes its direction, or alternates twice during each revolution of the generator shaft. Therefore, this type of current is called “alternating current” or AC. The path of the coil of wire is called its “circle of rotation,” and one complete “circle of rotation” is called one “cycle.” The changing value of the AC current generated in this manner is shown on the graph (See Fig. 8). The number of cycles through which the current passes in a given period of time is the same as the number of revolutions the coil makes in the same time. This is the “frequency of the current.” In the United States, most alternating current has a frequency of 60 cycles per second or, in more recent years, stated as 60 Hertz, named after Heinrich Hertz, a German physicist.

FIGURE 8

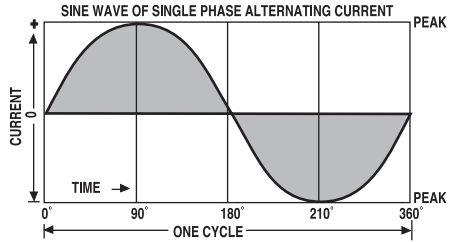

The single coil mounted on the generator shaft which we have used to explain alternating current will produce only one current. This is called “single phase” current. However, if we mounted three coils of wire about the shaft equal distances apart, each coil would produce an alternating current. This would be “three-phase” current, or “polyphase.” But since the coils are equally spaced around the “circle of rotation,” each coil will have a different amount of current at a particular moment. (See Fig. 9)

FIGURE 9

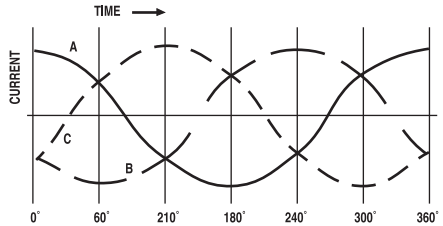

Single and three-phase currents are most common in this country, although there are a few generating systems that produce two-phase current. When a motor is called “polyphase” it will usually use three-phase current.

While there are both AC and DC motors, the most common type is the AC motor. Therefore, from here on, unless otherwise mentioned, we will confine ourselves to the AC motor.

FIGURE 10

This is an example of an AC Motor:

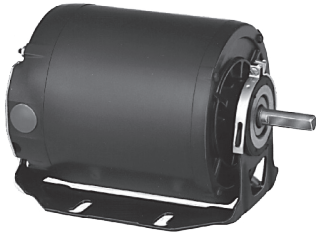

MOTOR CONSTRUCTION

Now that we have looked at the basic principles—electricity, work, power and energy—let’s now look at the mechanical parts of the motor. In later chapters we will look at the electrical characteristics.

The two major assemblies which form an electric motor are the Rotor and the Stator. The Rotor is made up of the shaft, rotor core (an assembly of laminations and diecast aluminum squirrel cage conductors and end rings), and usually a fan.

FIGURE 11



The other major part is the Stator. The stator is formed from steel laminations stacked and fastened together so that the notches (called slots) form a continuous lengthwise slot on the inside diameter. Insulation is placed to line the slots, and then coils wound with many turns of wire are inserted into the slots to form a circuit. The wound stator laminations are pressed or otherwise assembled within a cylindrical steel frame to form the stator.

FIGURE 12



FIGURE 13



The coils of wire are wound in a variety of designs, depending upon the electrical makeup of the motor. They provide two or more paths for current to flow through the stator windings.

When the coils have two centers, they form a two-pole motor; when they have four centers, they form a four-pole motor. In short, the number of coil centers determines the number of poles a motor has.

We now shall see how the number of poles determines the speed of the motor.

Sixty hertz power “cycles” 60 times each second, or 3600 times each minute. When the stator is wound in the form of two poles, they change their polarity 3600 times each minute. The rotating magnetic field induces the rotor conductors to follow. All alternating current induction motors “slip,” that is, they cannot quite keep up with the speed of the pole changes within the stator. The speed of the magnetic field within the stator is called the synchronous speed of the motor. A two-pole motor has a synchronous speed of 3600 RPM on 60 Hertz alternating current. However, slip accounts for an actual speed of 3450 RPM. This simple formula will help to determine the synchronous speed of an electric motor:

$$\frac{\text{Cycles per minute}}{\text{Pairs of pole}} = \text{Synchronous RPM}$$

This comparison chart may be helpful in determining how many poles an AC motor has:

The end bells or covers of any motor must fulfill several very important physical requirements. They must be strong enough to support the motor shaft bearings under the most severe load conditions, and they must be rigid to maintain alignment of the bearing bores throughout the life of the motor. Weights mounted on the shaft or hanging from the shaft, such as chain and sprocket or belt and sheave drives, must be supported by the output shaft end bell. This type of “overhung” loading usually determines the sizes of the new shaft bearing and the shape of the end bell.

FIGURE 14



Another very important function of the end bells is to center the rotor or armature accurately within the stator to maintain a constant air gap between the stationary and moving cores (stacks of laminations).

Motors smaller than five horsepower frequently have end bells made of aluminum alloy. This material has great strength, is lightweight, has an attractive appearance, and lends itself to mass production techniques. Large motors have end bells made from high grade cast iron because of its strength and rigidity.

Depending on the motor size and type of enclosure, end bells can have cooling openings to provide airways or ducts for the passage of air over and around the windings. The end bells of some motors have terminal board mountings for connecting the power line to the motor. Where necessary, provisions are made in the design of the end bells for the lubrication of the bearings.

MOTOR MOUNTINGS – Motors are mounted in many ways. The four most frequently used methods are: rigid mounted, resilient mounted, stud mounted and flange mounted.

RIGID MOUNT – The most common type of motor mounting is rectangular steel plate which conforms to the shape of the bottom of the case or frame of the motor. This is called "Rigid Mounting" because the frame of the motor is welded right to the base.

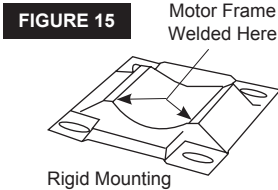

RESILIENT MOUNT – Another very common type of motor mounting is by means of rubber rings fitting over cylindrical notched parts of the end bells. The cylindrical parts support the weight of the motor while the notches keep it from turning within the rubber rings. These rings are bonded to a metal or molded plastic band surrounding the outside diameter of the rubber. In the turn, the metal or molded plastic bands are supported by a U-shaped steel support base and are firmly held in place with a simple screw-operated clamp arrangement.

Resilient mounting is one method of isolating the vibration or noise caused by

FIGURE 16

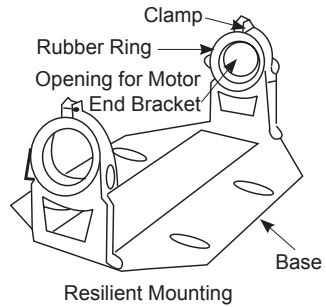

the motor drives. The rubber rings mentioned not only tend to quiet and isolate the motor from its surroundings, but afford a torque "cushion" for the motor, lessening the shock caused by starting or stopping.

STUD MOUNTING – A frequently used type of motor mounting is the stud mount. The main area of application is on small fan motors. The end bells of these motors are held together by two or more long bolts that project approximately 1" from the end bell at the shaft end of the motor. These bolt ends are secured to the cross bar of the fan housing with a nut and lock-washer.

FIGURE 17

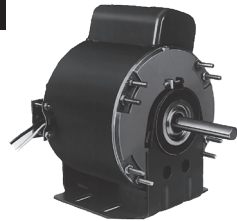

FLANGE MOUNTED – This usually requires an end bell with a special configuration, most commonly a machined flat surface perpendicular to the axis of the motor shaft and a machined pilot fit concentric with the shaft. It may have two or more holes (plain or tapped) through which bolts are secured. The most typical flange mountings are the oil burner and "NEMA" flanges.

FIGURE 18



BEARINGS – Two bearing types used in motors are the sleeve bearing and the ball bearing. Sleeve bearings, sometimes called bushings, are usually thin-walled tubes made from steel-backed babbitt or bronze. Oil grooves are cut on the inside surface to insure proper lubrication of the bearing. They may also be made from “oilite,” porous iron, or similar self-lubricating bearing materials. The porous nature of the material traps the lubricating oil in the sleeve and the shaft rides on a very thin layer of oil. When properly lubricated, there is no physical contact between the shaft and a sleeve bearing.

Sleeve bearings are used in the smaller motors for light and medium duty service. When correctly maintained by periodic lubrication, these bearings give years of trouble-free service.

Most sleeve bearings are designed for all position mounting, and may be used in the vertical position.

Generally speaking, all sleeve bearings are designed with an opening called a “bearing window.” The “window” is a rectangular hole in one side of the bearing which contains a wicking material. Its purpose is to feed oil by capillary action from the oil reservoir to the shaft. As the shaft turns, it wipes the oil from the wick and lubricates the bearing.

When motors with sleeve bearings are connected to loads with belts or chains which tend to pull the shaft to one side, care should be taken that the shaft is not pulled in the direction of the bearing window. This would effectively plug the window and improper lubrication could occur. The bearing window is generally located right below the oil hole in the end bracket. Consequently, be sure the belt pull is not in the direction of this hole.

FIGURE 19

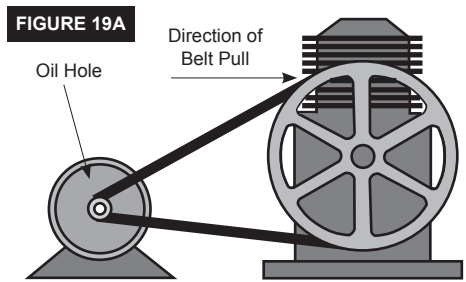

Ball bearings are formed by enclosing a number of hardened steel balls between grooved inner and outer rings of hardened steel called “races.” Sometimes a light metal spacer called a “cage” is used to space the balls evenly around the races. To insure long, maintenance-free life, these bearings can be packed with lubricant and sealed by mounting these metal discs or rings on each side of the opening between the inner and outer race.

INSULATION – In recent years, the trend in motor construction has been to small designs running at higher temperatures. Improved insulation systems have made these designs possible. Insulating materials or combinations of such materials are grouped into “temperature tolerance classes,” and these materials have been found to give satisfactory service and long life when operated within these temperature limits. At present, four classes are recognized by the American Institute of Electrical Engineers.

CLASS A INSULATION SYSTEMS – A Class A insulation system is a system utilizing materials having a preferred temperature index of 105 and operating at such temperature rises above stated ambient temperature as the equipment standard specifies based on experience or accepted test data. This system may alternatively contain materials of any class, provided that experience or a recognized system test procedure for the equipment has demonstrated equivalent life expectancy. The preferred temperature classification for a Class A insulation system is 105° C.

CLASS B INSULATION SYSTEM – A Class B insulation system is a system utilizing materials having a preferred temperature index of 130 and operating at such temperature rises above stated ambient temperature as the equipment standard specifies based on experience

or accepted test data. This system may alternatively contain materials of any class, provided that experience or a recognized system test procedure for the equipment has demonstrated equivalent life expectancy. The preferred temperature classification for a Class B insulation system is 130° C.

CLASS F INSULATION SYSTEM – A

Class F insulation system is a system utilizing materials having a preferred temperature index of 155 and operating at such temperature rises above stated ambient temperatures as the equipment standard specifies based on experience or accepted test data. This system may alternatively contain materials of any class, provided that experience or a recognized test procedure for the equipment has demonstrated equivalent life expectancy. The preferred temperature classification for a Class F insulation system is 155° C.

CLASS H INSULATION SYSTEM – A

Class H insulation system is a system utilizing materials having a preferred temperature index of 180 and operating at such temperature rises above stated ambient temperature as the equipment standard specifies based on experience or accepted test data. This system may alternatively contain materials of any class, provided that experience or a recognized test procedure for the equipment has demonstrated equivalent life expectancy. The preferred temperature classification for a Class H insulation system is 180° C.

FIGURE 20

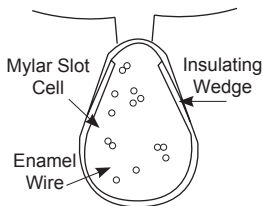

Now that we have covered the various classes of insulation, let's see what makes up the insulation system in a motor.

Remember that the speed of the motor is a function of the number of poles and

the frequency it is run on, as explained earlier in split phase motor. For example, there will be two separate coils in the same stator slot. These coils are wound one at a time, the first coil is placed in the bottom of the slot, and then the final coil is placed in the slot and locked in place by a wedge (fishpaper or other material) which closes off the slot.

The leads are then covered with insulating tubing and the entire stator is dipped in varnish and baked until it has a generous coating of varnish. This varnish is removed from the outside diameter of the stator and the stator may then be pressed or bolted into the motor frame, depending on the design. The leads are brought out and connected to the terminal block opposite the nameplate. This completes the insulated electrical circuit of the motor.

MOTOR ENCLOSURES

There are many types of motor enclosures. The most common type is the open, after which come the drip-proof, totally enclosed, and totally-enclosed fan cooled (TEFC). Here are brief descriptions of these and others.

OPEN MOTOR

An open motor is one having ventilating openings which permit passage of external cooling air over and around the windings of the motor. The term "open" designates a motor having no restriction to ventilation other than that necessitated by mechanical construction.

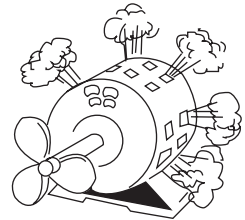

DRIP-PROOF MOTOR

A drip-proof motor is an open motor in which the ventilating openings are so constructed that successful operation is not interfered with when drops of liquid or solid particles strike



or enter the enclosure at any angle from 0 to 15 degrees downward from the vertical.

TOTALLY-ENCLOSED MOTOR

A totally-enclosed motor is one so enclosed as to prevent the free exchange of air between the inside and outside of the case but not sufficiently enclosed to be termed air-tight.

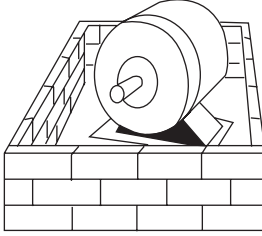

TOTALLY-ENCLOSED NONVENTILATED MOTOR (TENV)

A totally-enclosed nonventilated motor is not equipped for cooling by means external to the enclosing parts.

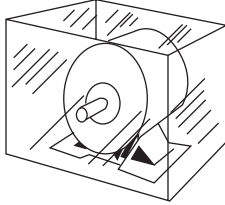

TOTALLY-ENCLOSED FAN-COOLED MOTOR (TEFC)

A totally-enclosed fan-cooled motor is equipped for exterior cooling by means of a fan or fans integral to the motor but external to the enclosing parts.

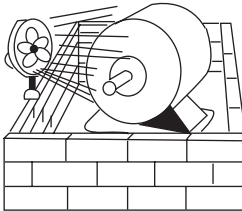

EXPLOSION-PROOF MOTOR

An explosion-proof motor's enclosure is designed and constructed to withstand an explosion of a specified gas or vapor which may occur within it and to prevent the ignition of the specified gas or vapor surround-



ing the motor by sparks, flashes or explosions of the specified gas or vapor which may occur within the motor casing.

DUST-IGNITION-PROOF MOTOR

A dust-ignition-proof motor is a totally-enclosed motor whose enclosure is designed and constructed in a manner which will exclude ignitable amounts of dust or amounts which might affect performance or rating, and which will not permit arcs, sparks, or heat otherwise generated or liberated inside the enclosure to cause ignition of exterior accumulations or atmospheric suspensions of a specific dust on or in the vicinity of the enclosure.

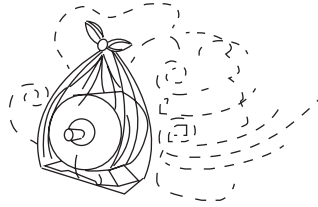

TOTALLY-ENCLOSED FAN-COOLED GUARDED MOTOR

A totally-enclosed fan-cooled guarded motor is a totally-enclosed fan-cooled motor in which all openings giving direct access to the fan are limited in size by the design of the structural parts or by screens, grilles, expanded metal, etc., to prevent accidental contact with the fan. Such openings shall not permit the passage of a cylindrical rod 0.75 inch in diameter and a probe shall not contact the blades, spokes or other irregular surfaces of the fan.

TOTALLY-ENCLOSED AIR-OVER MOTOR

A totally-enclosed air-over motor is intended for exterior cooling by a ventilating means external to the motor.

- 12 The service factor of a motor is a multiplier which, when applied to the nameplate (rated) horsepower, indicates a permissible horsepower loading that may be carried when the motor is operating at rated voltage and frequency. However, when operating at full service factor, both the current and temperature rise will increase.
- 13 This block indicates the type of power for which the motor has been designed. Some motors operate on single phase AC, others on three-phase AC.
- 14 Service factor amps is the current drawn by the motor when operating at a load that exceeds the horsepower rating. A motor with a service factor over 1.0 can be operated safely and continuously drawing current up to this limit until the current drawn exceeds this value.
- 15 This is a NEMA code letter designating the locked rotor kva per horsepower. For example, the letter M allows for from 10 to 11.2 kva per horsepower.
- 16 °C ambient maximum degrees centigrade of ambient air at which motor shall be operated.
- 17 Insulation class (see previous descriptions).
- 18 Housing or type of enclosure.
- 19 Wiring diagram.
- 20 A stock number, in addition to a style or model number, is commonly used on replacement motors, but not OEM motors.
- 21 Underwriters Laboratories' recognition symbol.
- 22 Canadian Standards Association symbol.

Now that we have learned a little bit about motor construction and what the data on the nameplate means, let's look at the various types of motors that are most commonly used.

AC INDUCTION MOTORS

AC SERIES MOTORS (UNIVERSAL)

In AC series or universal motors, the field coils are wound on a stator core and are in series with an armature winding. The electrical connections between the armature winding and the stator field windings are provided by a ring of segments on the

armature and by carbon brushes mounted in one end bell. The components of this motor are connected in this manner:

One wire of the power cord for series motors is connected to one end of one field coil. The other end of the same field is connected to a brush. The other brush is connected to one end of the second field coil, and the other end of this field is connected to the second wire of the power cord. The electric current passes directly through each coil in the motor, step by step, and this is why the motor is called a series motor.

Motors of this type are called "universal" motors because they can run on either alternating current or direct current. They operate at speeds as high as 35,000 rpm or, in other words, 35,000 complete turns of the shafts in one minute. Their high starting torque and their ability to adjust to widely varying loads make them ideal for electric shavers, drills, saws, sanders, blenders, vacuum cleaners, and other portable household appliances.

SINGLE PHASE INDUCTION MOTORS SPLIT PHASE-CAPACITOR-SHADED POLE- PERMANENT SPLIT CAPACITOR (PSC)

The stator of a split phase motor has two types of coils, one is called the running winding and the other the starting winding. The running winding is made by winding the enamel coated wire through the slots in the stator punchings, as mentioned in the chapter on motor construction.

The starting winding is made in the same way, except that the wire is usually smaller. Coils that form the starting windings are positioned in pairs in the stator directly opposite each other and between the running windings. When you look at the end of the stator, you see alternate running windings and starting windings.

FIGURE 21

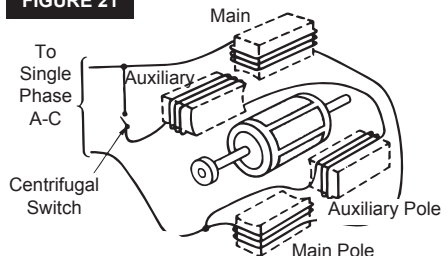

The running windings are all connected together, so the electrical current must pass through one coil completely before it enters the next coil, and so on through all of the running windings in the stator. The starting windings are connected together in the same way and the current must pass through each in turn.

The two wires from the running winding in the stator are connected to terminals on an insulated terminal block in one end bell where the power supply is attached to the same terminals. One wire from the starting winding is tied to one of these terminals also. However, the other wire from the starting winding is connected to the stationary switch mounted in the end bell. Another wire then connects this switch to the opposite terminal on the insulated block. The stationary switch does not revolve, but is placed so the weights in the rotating portion of the switch, located on the rotor, will move outward when the motor is up to speed, and open the switch to stop electric current from passing through the starting winding.

FIGURE 22

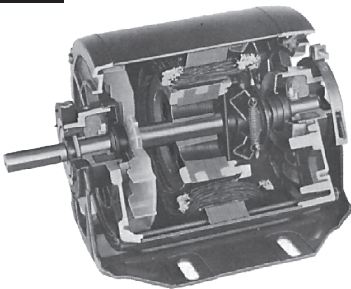

The motor then runs only on the main winding until such time as it is shut off. Then, as the rotor decreases in speed, the weights on the rotating switch again move inward to close the stationary switch and engage the starting winding for the next time it is started.

FIGURE 23

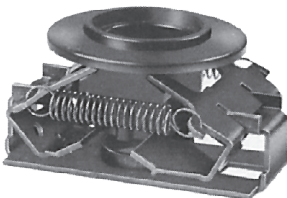

The **capacitor motor** differs from a split-phase motor in that a capacitor is placed in the path of the electrical current to the starting winding. Except for the capacitor, which is an electrical component that “cushions” any rapid change in the current, the two motors are the same electronically. A capacitor motor can usually be recognized by the capacitor can or housing that is mounted on the stator.

FIGURE 24

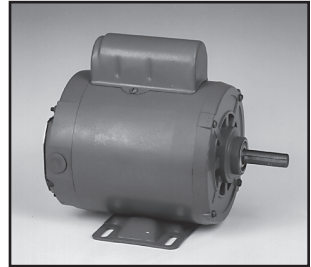

There are three types of capacitor motors:

1. **Capacitor-Start Motor** — a capacitor motor in which the capacitor is in the circuit only during starting.
2. **Two-Value Capacitor Motor (Cap Start-Cap Run)** — a capacitor motor with different values of capacitance used for the starting and running conditions.

Adding the capacitor to the starting winding increases the effect of the two-phase field described in connection with the split phase motor, and produces a much greater twisting force when the motor is started. It also reduces the amount of electrical current required during starting to about 1-1/2 times the current required after the motor is up to speed whereas split phase motors require 3 or 4 times the current in starting that they do in running.

Capacitor motors are available in sizes from 1/6 Hp to small integral. They are used for fairly hard starting loads that can be brought up to running speed in under three seconds, such as industrial motor tools, pumps, air conditioners, air compressors, conveyors, and hoists. There are also two types of capacitor motors, one rated for general purpose (NEMA service factors) and the other for special service (no service factor).

3. **Permanent-Split Capacitor Motor (PSC)**— a capacitor motor having the same value of capacitance for both starting and runnings conditions.

These motors have a permanently connected capacitor in the winding circuit, thus eliminating the starting switch described for the split-phase motor. Because of comparatively low starting torque, these motors are primarily applicable to shaft-mounted fans and blowers.

In the **Shaded Pole Motor** a loop of heavy copper strap or wire replaces the starting winding. This loop of copper is mounted in the face of the steel laminations. A groove is provided so that approximately 1/3 of the laminations that make up the pole face are completely encircled by the copper loop. As the amount of current in the main winding increases, the portion of the pole that is not enclosed in the copper loop produces a strong magnetic field centered at its face. When the exciting current reaches its maximum value, the center of the magnetic field will move to the center of the entire face. Then, as the exciting current decreases in value, the magnetic center will shift to the portion of the face enclosed in the loop of copper.

FIGURE 25

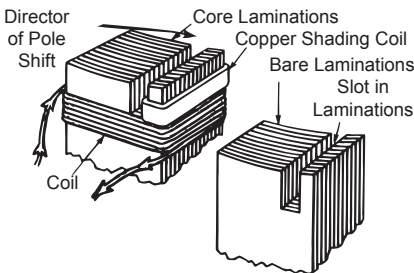

This shifting of the magnetic field, first away from and then toward the loop of copper, is caused by an induced current in the loop of copper which "shades" the pole. As the current increases in the exciting winding, a secondary current is induced in the loop of copper which weakens the magnetic field on that portion of the face enclosed by the strap. As the current levels off in the exciting winding, the induced current in the loop stops and the entire face produces the same magnetic field. Then as the current

decreases in the exciting winding, a new current is induced in the loop of copper, but in the opposite direction, so that the loop now tries to maintain the magnetic field in the portion of the face enclosed in the loop.

By shifting the magnetic field across the face of the pole, the rotor is induced to turn and follow the magnetic field. The continuous pulsation produced by the alternating current produces a weak rotating field that makes continuous rotation possible.

Shaded pole motors can be reversed mechanically by turning the stator housing and shaded poles end for end. These motors are available from 1/250 to 1/2 horsepower, and are used for such low-torque, light-duty load applications as small blowers, ceiling exhaust fans and small appliances.

The **Repulsion-Start Induction Motor** starts on one principle of operation and, when almost up to speed, change over to another type of operation. Very high twisting forces are produced during starting by the repulsion between the magnetic pole in the armature and the same kind of pole in the adjacent stator field winding. The repulsing force is controlled and changed so that the armature rotational speed increases rapidly and, if not stopped, would continue to increase beyond a practical operating speed. This is prevented by a speed-actuated mechanical switch that causes the armature to act as a rotor which is electronically the same as the rotor in single-phase induction motors. That is why the motor is called a repulsion-start induction motor.

The stator of this motor is constructed very much like that of a split phase or capacitor motor, but there are only running or field windings mounted inside. End bells keep the armature and shaft in position and hold the shaft bearings.

The armature consists of many separate coils of wire connected to segments of the commutator. Mounted on the other end of the armature are governor weights which move push rods that pass through the armature core. These rods push against a short circuiting ring mounted on the shaft on the commutator end of the armature. Brush holders and brushes are mounted in the commutator end bell, and the brushes, connected by a heavy wire, press against segments on opposite sides of the commutator.

When the motor is stopped, the action of the governor weights keeps the short circuiting ring from touching the commutator. When the power is turned on and current flows through the stator field windings, a current is induced in the armature coils. The two brushes connected together form an electromagnetic coil that produces a north and south pole in the armature, positioned so that the north pole in the armature is next to a north pole in the stator field windings. Since like poles try to move apart, the repulsion produced in this case can be satisfied in only one way, by the armature turning and moving the armature coil away from the field windings.

FIGURE 26

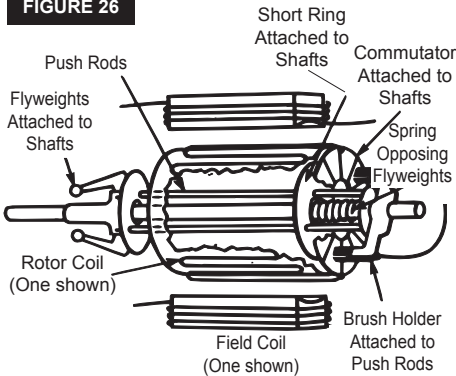

The armature turns faster and faster, accelerating until it reaches a speed that is approximately 80% of the running speed. At this speed, the governor weights fly outward and allow the push rods to move. These push rods, which are parallel to the armature shaft, have been holding the short circuiting ring away from the commutator. Now that the governor has reached its designed speed, the rods can move, and the short circuiting ring is pushed against the segments of the commutator by a spring, tying them all together electrically in the same manner that the cast aluminum discs did in the cage of the induction motor rotor. Thus, the motor runs as an induction motor.

Motors of this type can start very heavy, hard-to-turn loads without drawing too much current. Available from 1/2 to 20 horsepower, they are used for such applications as large air compressors, refrigeration equipment, large hoists, and are particularly useful in locations where low line voltage is a problem.

POLYPHASE INDUCTION MOTORS

The simplicity of a three-phase induction motor can be attributed to the three-phase power supplied to the stator windings. Three identical sets of running windings are mounted in the stator, and each set of windings is connected to a different phase of the power source. The relationship of the increase or decrease, or rise and fall of the current in each phase with that of the other phases produces the rotating magnetic field that in turn produces the twisting motion in the motor shaft.

For identification of phases, let's call the three phases A, B, and C. Phase B is displaced time-wise from Phase A by 1/3 of a cycle, and Phase C is displaced from Phase B by 1/3 of a cycle. In the stator, the different phase windings are placed adjacent to each other so that a B winding is next to an A, a C is next to a B, and then an A is next to a C, and so on around the stator. (See Fig. 27)

FIGURE 27

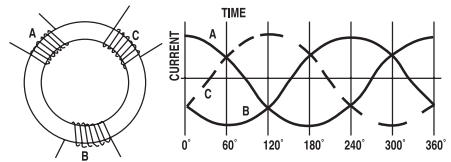

Now picture in your mind the magnetic fields produced by the three phases in just one group of A, B and C windings for one cycle. We will start with the A phase at its maximum positive peak current value and say that this A winding is a north pole at its maximum strength. As we move along the cycle, the magnetic pole at A will decrease to zero as the current changes direction, it will become a south pole. The strength of the field will increase until the current reaches its greatest negative value, producing a maximum strength south pole, then decrease, pass through zero or neutral, and become a maximum strength north pole at the end of the cycle.

The B phase winding does exactly the same thing, except that the rise and fall of the magnetic fields follow behind the A phase by 1/3 of a cycle, and the C phase winding magnetic field follows behind the B phase by

1/3 of a cycle and the A phase by 2/3 of a cycle.

Let's assume that we can see only the maximum north poles produced by each phase and that we are looking at the end of a complete stator connected to a three-phase power source. The north poles would move around the stator and appear to be revolving because of the current relationship of the A, B and C phases.

Three-phase rotors have a rotor core pressed onto the motor shaft that consists of an assembly of laminations with diecast aluminum conductors and connecting end rings to form a cage for the electrical current. The rotating magnetic field in the stator induces current into this electrical cage and thereby sets up north and south poles in the rotor. These north and south poles then follow their opposite members in the stator and the shaft rotates. Polyphase induction motors are often called squirrel-cage motors because of their rotor construction.

This rotating magnetic field, which is a characteristic of three-phase induction motors, there eliminates the starting windings and auxiliary equipment that are required to start all single-phase induction motors. Construction and maintenance are greatly simplified.

The polyphase or three-phase induction motor has been almost universally adopted by industry as the most practical electric motor. These motors are available in a range from 1/4 to hundreds of horsepower. Their characteristics can be adapted to suit any type of load and to serve practically every industrial need.

The National Electrical Manufacturers Association (NEMA) has established standards for four design types (identified by design letters A through D) with each providing different starting and running operating characteristics. These four types are made by controlling the shape of the electrical conductors cast into the grooves in the rotor, the air space between the rotor and the stator, and the number of turns of wire in each stator coil and how it is positioned in the stator.

Manufacturers design motors so that they can be connected to either 230 volt three-phase or 460 volt three-phase by simply rearranging the lead connections from the

stator windings. We know that we must have one winding for each phase. In a 230v/460v or dual voltage motor, two windings are provided for each phase. Each winding is designed for 230 volts. If we run the motor on 230 volt power, both windings for one phase are connected so that they split the current between them. However, if the motor is run on 460 volt power, the current in each phase must pass through one coil before it enters the second coil.

FIGURE 28A

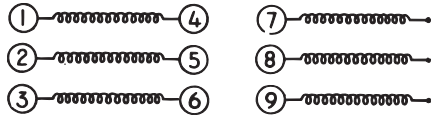

To simplify the connecting of the correct coil to the correct power phase, nine leads or connections are provided in the field coils. The way the coils are numbered is easy to remember if you place the numbers in three columns, with the coils 1, 2 and 3, and after 7, 8 and 9.

If we want to connect the coils for 460 volts or in series, we know which numbers to connect together.

FIGURE 28B

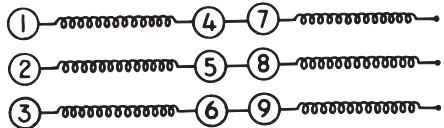

Or, if we want the coils connected for 230 volts we can connect them in parallel.

FIGURE 28C

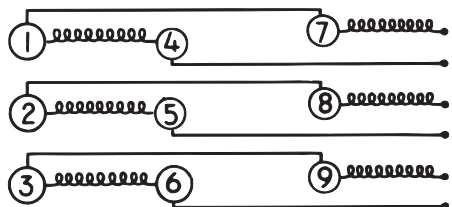

There are two different arrangements for connecting the windings of a three-phase motor. They are called "star" and "delta." To

form a star, the phase windings are connected as shown in Fig. 28D.

The three wires that supply power to the motor are labeled A, B and C and are connected to 1, 2 and 3.

To form a delta, the phase windings are connected as shown in Fig. 28E.

FIGURE 28D

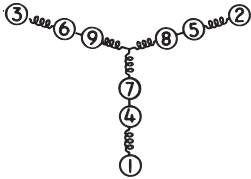
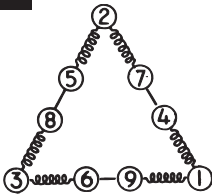
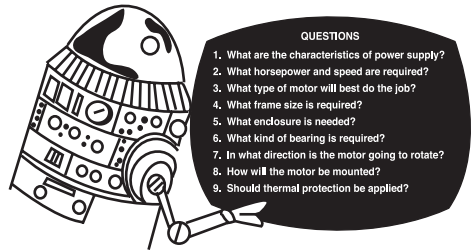

FIGURE 28E



Here again, the three wires that supply power to the motor are labeled A, B and C and are connected to 1, 2 and 3. No matter how a three-phase motor is connected, its direction of rotation can be changed by reversing any two of the three-phase power connections. In the last example of a delta connection, if we wanted to reverse the motor we could change A and B so that A was connected to terminal 2 and B to 1. If you have occasion to determine how a motor is connected, just write down the numbers 1 through 9 in three columns, with the coils positioned by the proper numbers, and then connect the numbers as they are in the motor.

These, then, are the basic types of AC motors in common use today. Where each is used depends primarily on the application. In the next chapter we shall see how a simple set of questions can properly identify which type of motor is correct for any given application.



- QUESTIONS**
1. What are the characteristics of power supply?
 2. What horsepower and speed are required?
 3. What type of motor will best do the job?
 4. What frame size is required?
 5. What enclosure is needed?
 6. What kind of bearing is required?
 7. In what direction is the motor going to rotate?
 8. How will the motor be mounted?
 9. Should thermal protection be applied?

SELECTING THE PROPER MOTOR

Selection of the correct motor for the job to be done is a matter of considering a few basic points. In previous chapters the types of motors commonly in use today have been shown, as well as the electrical and mechanical characteristics as shown on pages 26-29. With these differences known, proper motor selection becomes a matter of elimination. As each of the specific questions listed below is answered, the choice of the correct motor is narrowed, until the proper motor remains. That, then is the motor that will best do the job.

QUESTION #1

What are the characteristics of the power supply?

AC or DC?

Single or Polyphase?

50 or 60 cycles?

Voltage?

The motor must fit the power supply. The first question is, whether the electric current available is AC or DC. If the current is AC, this eliminates all DC motors. The second part of the question is whether the current is single or polyphase. As single phase is most common for homes, farms, and offices, and polyphase for industrial plants, the answer is easily learned. If it is single phase, you can eliminate polyphase motors. The next question is frequency. Single phase current throughout North America is 60 Hertz. 50 Hertz current is common in much of Europe. Whatever the answer, you have narrowed the choice still further. The final question is, what is the voltage? Most common single phase voltage is 115/230. Many single phase motors will operate on these voltages, so the

next step in selection is to answer Question #2.

QUESTION #2

What horsepower and speed are required?

As seen in the Work, Power and Energy chapter, horsepower is the capability to do a given amount of work. Motors are rated in horsepower (or watts), either fractional or integral. 746 Watts = 1 HP.

Breakdown torque is the maximum torque or load the motor will carry without stalling.

Torque characteristics of various motors are best described by comparing one type with another. Accordingly, the chart inside indicates torques as “very low,” “low,” “medium,” “high,” and “extra high.” Approximate torques indicated by these terms are:

	Locked rotor torque <i>(in relation to running torque)</i>	Breakdown torque <i>(in relation to running torque)</i>
Very Low	Below 85%	—
Low	85 to 175%	Below 175%
Medium	175 to 250%	175 to 220%
High	250 to 400%	220 to 270%
Very High	Above 400%	270% and up

To reduce possibility of light flicker, many power companies restrict the use of motors with high starting current. This explains why use of high torque split phase motors occasionally meets with objections except where operated infrequently as on washing machines, ironers and home workshop devices. However, with the above exceptions, all motors listed in Table 1 have locked-rotor currents within the following NEMA standards for 115-volt motors:

1/6 hp and below	20 amperes
1/4 hp	26 amperes
1/3 hp	31 amperes
1/2 hp	45 amperes
3/4 hp	61 amperes

Horsepower rating depends upon speed, so both of these factors must be determined. In the chapter discussing motor construction, it was mentioned that most small motors are either 2 pole (3450 rpm), 4 pole (1725 rpm), 6 pole (1140 rpm), or 8 pole (850 rpm).

The first thing to determine is the desired full load speed, and then the desired horsepower at that speed. Generally speaking these two facts are known.

If they are not, an expert must be consulted, and the proper tests run to determine the horsepower requirements. With these two factors known, the choice is narrowed even further, and one is not buying extra horsepower that is unnecessary. Go on to the next question.

QUESTION #3

What type of motor will best do the job?

Shaded Pole?

Split Phase?

Capacitor?

Two-Capacitor?

Permanent Split Capacitor?

Three Phase?

The preceding chapters described the characteristics of the most commonly used types of small motors.

This and other information is detailed on pages 26-29. The two factors that are probably most important in determining which type of motor to use are the type of torque requirements of the load and the starting current limitations. Many applications such as pumps and compressors may require more torque to start and accelerate the load than to run it. Others, such as direct-connected propeller fans, may require more torque to run the load than to start it. Motor torque characteristics must match those of the load. It is therefore necessary to consider load requirements in terms of starting torque and breakdown torque. These may be defined as follows:

Starting torque or locked rotor torque is the turning effort produced by the motor at the instant of start.

Therefore, generally speaking, this question can be answered by matching up the torque and starting current requirements of the application with the torque and starting current characteristics of the various motors available on the market. Pages 26-29 provide a summary of the information necessary to do this and get the answer to Question #3.

QUESTION #4

What frame size is required?

Remember that the most common small motor frame sizes are the 42, 48 and 56 frames. NEMA has set certain standards for the dimensions of these frame sizes and most manufacturers build their motors to conform to these standards. More detailed dimen-

sions of the 48 and 56 frame sizes are shown in Exhibit A, but you can usually tell what the frame size of the motor is by checking one or all of these dimensions:

Frame	Shaft Diameter	Flat or Keyway	"D" ¹ Dimension	Frame Diameter (Approx)
42	3/8"	flat	2-5/8"	4-7/8"
48	1/2"	flat	3"	5-7/8"
56	5/8"	keyway	3-1/2"	6-3/4"
140	7/8"	keyway	3-1/2"	6-1/4"

1. "D" Dimension is the distance from the floor or mounting surface to the center line of the shaft.

Therefore, check one of these dimensions or, if necessary, refer to Exhibit A and you can answer Question #4.

EXHIBIT A

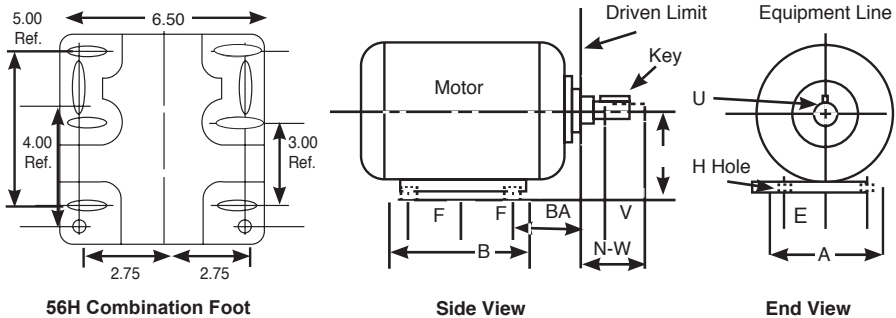

Standard NEMA motor frame dimensions.

Frame	Common to All Squirrel Cage Motors						
	D	E	F	BA	U	N-W	Key Size
42	2-5/8	1-3/4	27/32	2-1/16	3/8	1-1/8	.05 Flat
48	3	2-1/8	1-3/8	2-1/2	1/2	1-5/8	.05 Flat
56	3-1/2	2-7/16	1-1/2	2-3/4	5/8	1-7/8	3/16 sq. x 1-3/8
56H	3-1/2	Dia. 1	Dia. 1	2-2/34	5/8	1-7/8	3/16 sq. x 1-3/8
56C	See Below				5/8	1-7/8	3/16 sq. x 1-3/8
56J	See Below				5/8	2-7/16	Threaded
143T	3-1/2	2-3/4	2	2-1/4	7/8	2-1/4	3/16 sq. x 1-3/8
145T	3-1/2	2-3/4	2-1/2	2-1/4	7/8	2-1/4	3/16 sq. x 1-3/8

NOTE:
Y suffix =
Special
mounting
dimension

Z suffix =
Special shaft
dimension

EXHIBIT A (continued)

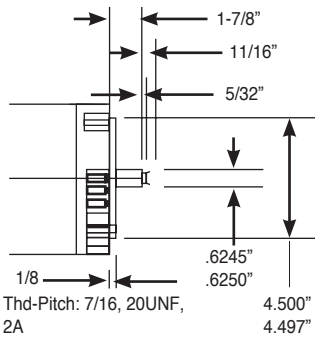

56J

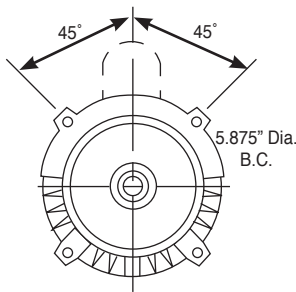

4 Mounting Holes 3/8-16, UNC 2B,
Max. Depth of Screw in Casting: 5/8"

56C (FACE)

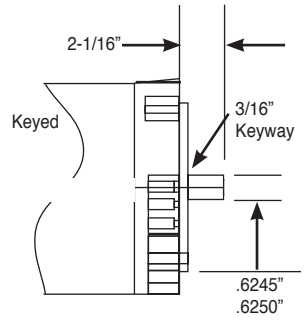

56C

Square Flange

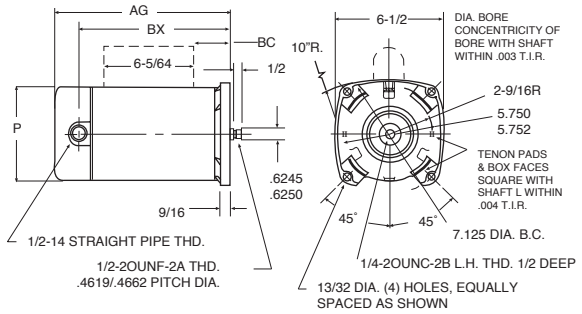

QUESTION #5

What enclosure is needed?

- Open drip-proof?
- Totally enclosed?

Most small motors are drip-proof guarded since this type is adequate for a great many applications. However, in some cases, motors are used in atmospheres when moisture, dust or other corrosive agents are prevalent and which could harm the motor windings. In these cases, totally enclosed motors usually solve the problem. By referring back to the section on motor enclosures, you can easily match up the needs of the application with the proper enclosure and you have answered Question #5.

QUESTION #6

What kind of bearing is required?

On most applications, sleeve bearings will do the job. They are less expensive, generally quieter and, on light duty applications, will perform for a minimum of 25,000 hours without lubrication. Ball bearings are recommended where the axial or radial thrust of the load exceeds 20 pounds.

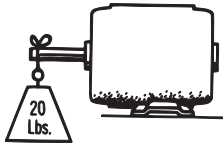

QUESTION #7

In what direction is the motor going to rotate?

Although the rotation of many small motors can be easily reversed (See pages 26-29), this is sometimes a very important question. Rotation is determined by looking at the end of the motor opposite the shaft extension end. The common reference is "CW" clockwise, and "CCW" counterclockwise, (except pump motors).

QUESTION #8

How will the motor be mounted?

This question is easily determined by just looking at the application, and there are two things to look for: Whether the motor is to be horizontal or vertical, and the type of mounting necessary. Remember that if the motor will be mounted in the vertical position, then care must be taken to see that the motor has either a ball bearing or sleeve bearing designed to operate in the vertical position.

The four most common motor mountings: rigid, resilient, flange and stud are described on page 10. Now, one more question, and you have the proper motor description.

FOOT MOUNTED MOTORS

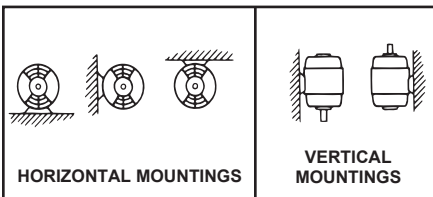

QUESTION #9

Should thermal protection be applied?

Thermal protection in a motor is provided by a temperature sensitive element which activates a switch. This switch will stop the motor if the motor reaches the pre-set temperature limit. Two major types of thermal protection switches are available. One will re-start the motor when the temperature has

been reduced. This type is called "Automatic Reset" (it automatically resets the switch). The other type is called "Manual Reset" (this type usually is in the form of a small pushbutton on the end of the motor opposite the shaft). When the motor has cooled sufficiently, the button is pushed and the motor will start.

Automatic reset protection would be very dangerous on a drill press, for example, because the motor may have cooled to the point where it will automatically re-start, just as the operator is loosening the chuck with a chuck key. For applications that involve drives of power tools which are exposed, or could be harmful if started without warning, always use manual restart.

However, by the same token, a fan or furnace blower motor would be well to have automatic protection.

With these nine questions answered, you have all the information for selection of the correct motor. As you can see, in many cases a single question will give you all eight answers. This is particularly true in selecting a replacement motor when all the information is known.

To further aid in making proper selection easy, the chart on the following page lists information on the motors we have discussed, and gives characteristics and general applications. With your understanding of the basic electrical and mechanical questions, use of the Small Motor Selector Chart can aid in fast, accurate pin-pointing of the correct motor for any application.

One factor should be mentioned at this time. In general practice, it is usually more economical to purchase a new motor in the fractional or small motor category than to repair it if it has burned out.

TYPICAL SPEED TORQUE CURVES FOR VARIOUS TYPES OF FRACTIONAL HORSEPOWER MOTORS

Most fractional horsepower alternating current motors are of 2, 4, 6 or 8-pole construction. For purposes of comparison, the characteristics of the AC motors indicated by these curves are based on 4-pole, 1725 rpm design.

FH General Purpose Split Phase

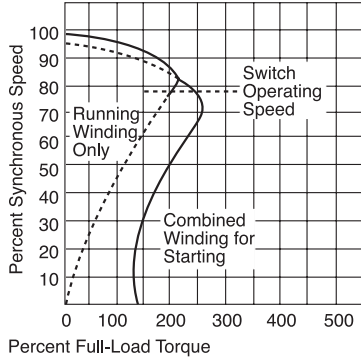

FH High Starting Torque Split Phase

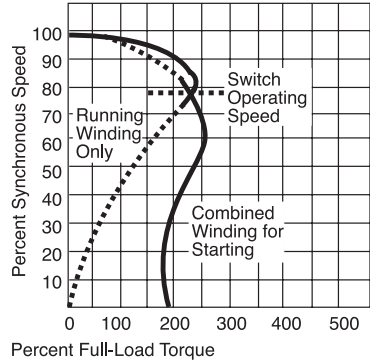

FJ General Purpose Capacitor Start

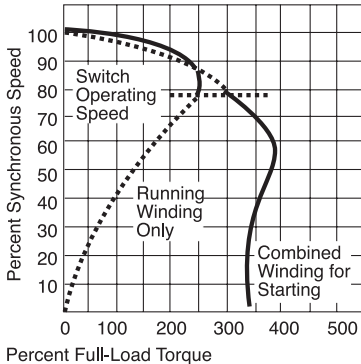

FS Polyphase

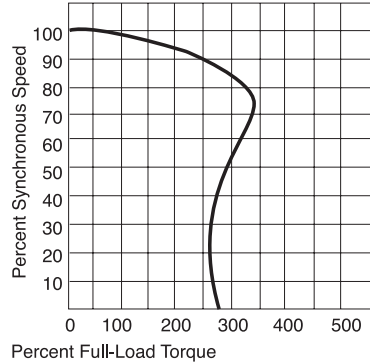

Voltage Variation Effects

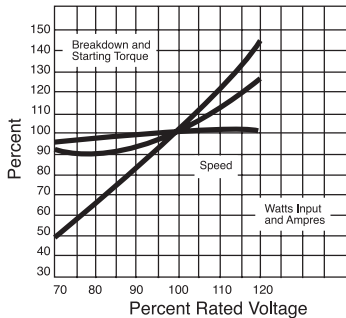

Effects of voltage variation on typical a-c fractional hp motor characteristics.

Breakdown Torques by Horsepower

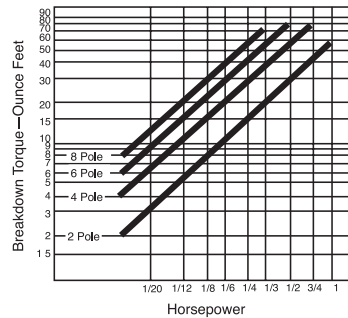

Breakdown torque ranges for determining hp rating 60 Hertz single phase motors

SMALL MOTOR SELECTION GUIDE

Most fractional horsepower motors are used on home, farm and office appliances where ordinarily only single phase power is available. Because torque requirements of these appliances vary widely and because it usually desirable to use the lowest priced motors that will drive them satisfactorily, many different types of single phase motors have been developed.

The chief difference in these types lies in the method used to start the motor. Single-phase induction motors, as such, are not self-starting because they cannot produce a rotating magnetic field as can a polyphase motor. To make them self-starting, it is necessary either to create a rotating field artificially during the starting period, or to

develop a motor which, during its starting period, is not an induction motor. Shaded pole, split phase and capacitor motors are in the former class. In the latter class is the repulsion start induction motor.

Each type has characteristics eminently suited to certain applications. This guide outlines comparative characteristics of the principal standard types which meet the needs of the vast majority of applications. Modifications or special types can be built to meet virtually any combination of electrical and mechanical specifications, but a standard type, if applicable, has many advantages, such as lower cost, quicker delivery and increased serviceability.

Type of Motor	Wiring Diagram	Range	Speed Data		Approximate Torque		
			Rated Speed	Speed Characteristics	Speed Control	Starting	Breakdown
Single Phase-Capacitor General Purpose Capacitor-Start		1/6 to 2	3450 1725 1140	Constant	None	High	High
Definite Purpose Capacitor-Start		1/4 to 1	3450 1725	Constant	None	Medium	Medium
Two Capacitor		1/2 to 2	3450 1725	Constant	None	High	High
Two-Speed Capacitor-Start (Two-Windings)		1/6 to 3/4	1725/ 1140	Two-Speed	1 Pole Double Throw Switch	Medium	Medium
Two-Speed Capacitor-Start Two Windings		1/4 to 1	1725/ 1140	Two-Speed	1 Pole Double Throw Switch	Medium	Medium
Permanent Split Capacitor		1/20 to 3/4	1625/ to 1075	Varying or Adjustable Varying	Tapped Winding or Choke Coil	Very Low	Low

Key to Symbols Shown in Wiring Diagrams



POWER SUPPLY

The motor must fit the power supply. It is therefore necessary to know the voltage, frequency and number of phases. All motors listed in this publication use AC power supply.

1/6 HP and below	20 amps	1/3 HP	31 amps
1/4 HP	23 amps	1/2 HP	45 amps
		3/4 HP	61 amps

STARTING CURRENT LIMITATIONS

Because of the possibility of light flicker, high torque split phase motors occasionally meet with objections except when operated infrequently as on washing machines and home workshop devices. However, with the above exception, all motors listed inside have locked-rotor currents within the following NEMA standards for 115 volt motors:

HORSEPOWER

The motor must be able not only to start and run the appliance, but to handle any momentary overload imposed by the particular application. If there is any doubt regarding horsepower and speed, an application test should be made to determine the size motor required to carry the load under all operating conditions without overheating. Duty cycle as well as frequency of starting may also affect size needed.

Built-in Starting Mechanism	Reversibly		Approximate Comparative Price	Bearings	Mountings	Service Factor ¹
	At Rest	In Motion				
Centrifugal Switch	Yes – Change Connections	No – Except w/ Special Design & Relay	100%	Sleeve or Ball	Various	Yes
Application Data: <i>Ideal for all heavy-duty drives, such as compressors, pumps, stokers, refrigerators, air conditioning. All purpose motor for high starting torque, low starting current. Quiet, economical, high efficiency. Single voltage in 1/4, 1/3 hp., 1725 rpm. ratings—dual voltage in others.</i>						
Centrifugal Switch	Yes – Change Connections	No	95%	Sleeve or Ball	Various	No
Application Data: <i>For use on applications such as attic fans, evaporative coolers, farm and home workshop tools, etc., where only a moderately high starting torque is required.</i>						
Centrifugal Switch	Yes – Change Connections	No	110%	Sleeve or Ball	Various	Yes
Application Data: <i>Motor for higher torque applications. Also, higher efficiency.</i>						
Centrifugal Switch	Yes – Change Connections	No	170%	Sleeve or Ball	Various	Yes
Application Data: <i>Two-speed used in applications where service factor and lower starting amps are required.</i>						
Centrifugal Switch	Yes – Change Connections	No	160%	Sleeve or Ball	Various	No
Application Data: <i>This motor applies to two-speed requirements.</i>						
None	No – Except with Special Design	No – Except with Special Design	160%	Sleeve or Ball	Various	No
Application Data: <i>Used primarily for direct-connected fans and blowers in room air conditioners, packaged terminal air conditioners, condenser units, furnaces and unit heaters. Not for belt drives. Very high efficiency and power factor. Motor output must be accurately matched to fan load to obtain desired operating speed and air flow.</i>						

1. Motors marked "No" in this column have a service factor of 1.0 and are not suitable for applications where the load will continuously exceed the nameplate rating.

OVERLOAD PROTECTION

When a motor is subject to overload or abnormal heat, built-in Thermoguard® protection should be used. This is particularly essential on devices for automatic operation where severe overload may be encountered, as on domestic refrigerators and furnaces. Types obtainable are described on the last pages.

MECHANICAL CONSIDERATIONS

Mechanical considerations such as type of bearings, method of mounting and degree of enclosure may also govern choice. In this selector various frame and mounting arrangements are illustrated. Such modifications are not necessarily available for all sizes and types.

TORQUE

Many applications, such as pumps and compressors, may require more torque to start and accelerate the load than to run it. Others, such as direct-connected fans and blowers, may require more torque to run the load than to start it. Motor torque characteristics must match those of the load. Testing should be taken at reduced line voltage to ensure that the motor has sufficient starting torque and breakdown torque to operate during starting and at peak loads under the lowest voltage conditions likely to be encountered. It is therefore necessary to consider load requirements in terms of starting torque and breakdown torque. These may be defined as follows:

Type of Motor	Wiring Diagram	Range	Speed Data			Approximate Torque	
			Rated Speed	Speed Characteristics	Speed Control	Starting	Breakdown
Single Phase Split Phase General Purpose		1/2 to 3/4	3450 1725 1140	Constant	None	Low	Medium
Definite Purpose		1/6 to 1/2	3450 1725	Constant	None	Medium	Medium
Two-Speed (Two Windings)		1/6 to 3/4	1725/ 1140	Two-Speed	1 Pole Double Throw Switch	Low	Medium
Two-Speed (Two Windings)		1/6 to 1/2	1725/ 1140	Two-Speed	1 Pole Double Throw Switch	Medium	Medium
Single Phase - Shaded Pole Shaded Pole		1/30 to 1/4	3000 1550 1050	Constant or Adjustable Varying	Tapped Winding or Choke Coil	Very Low	Low
Polyphase-3Phase General Purpose		1/6 to 5	3450 1725 1140	Constant	None	High	Extra High

Key to Symbols Shown in Wiring Diagrams



Starting torque or locked rotor torque is the turning effort produced by the motor at the instant of start. Breakdown torque is the maximum torque or load the motor will carry without an abrupt drop in speed.

Torque characteristics of various motors are best described by comparing one type with another. Accordingly, the chart inside indicates torques as “very low,” “low,” “medium,” “high,” and “extra high.” Approximate torques indicated by these terms are:

	Locked rotor Torque (in relation to running torque)	Breakdown Torque (in relation to running torque)
Very low	Below 85%	—
Low	85 to 175%	Below 175%
Medium	175 to 250%	175 to 220%
High	250 to 400%	220 to 270%
Extra High	Above 400%	270 and up

Permissible cost may dictate choice between types of similar characteristics. Comparative costs are therefore indicated in this guide in the form of relative percentages.

PRICE

FURTHER INFORMATION REFER TO PRICE LIST 2820.MOTOR REPLACEMENT

Built-in Starting Mechanism	Reversibly		Approximate Comparative Price	Bearings	Mountings	Service Factor ¹
	At Rest	In Motion				
Centrifugal Switch	Yes – Change Connections	No – Except w/ Special Design	75%	Sleeve or Ball	Various	Yes
<i>Application Data:</i> For oil burners, office appliances, fans, blowers. Low locked-rotor current minimizes light flicker, making motor suitable for frequent starting. For applications up to 3/4 hp where medium starting and breakdown torques are sufficient.						
Centrifugal Switch	Yes – Change Connections	No – Except Special Design & Relay	70%	Sleeve or Ball	Various	No
<i>Application Data:</i> For applications requiring more starting torque. Ideal for evaporative coolers, air circulating fans, pumps, attic fans, farm and home workshop tools. For continuous and intermittent duty where operation is infrequent and locked-rotor current in excess of NEMA values is not objectionable. May cause light flicker on underwired or overloaded lighting circuits.						
Centrifugal Switch	Yes – Change Connections	No	110%	Sleeve or Ball	Various	Yes
<i>Application Data:</i> For belted furnace blowers, attic ventilating fans, similar belted medium-torque jobs. Simplicity permits operation with any 1 pole double-throw switch or relay. Starts well on either speed—thus used with thermostatic or other automatic control.						
Centrifugal Switch	Yes – Change Connections	No – Except Special Design & Relay	97%	Sleeve or Ball	Various	No
<i>Application Data:</i> 2 speed, but more starting torque.						
None	No	No	–	Sleeve	Various	No
<i>Application Data:</i> Window fans and other direct-connected fan and blower applications—but power factor and efficiency is lower.						
Centrifugal Switch	Yes – Change Connections	Yes – Change Connections	110%	Sleeve or Ball	Various	Yes
<i>Application Data:</i> For pumps, compressors, motor tools and all general applications when polyphase power is available. Special designs are available with extra high starting torque for hoists, door operators, tool traverse and clamp devices.						

1. Motors marked “No” in this column have a service factor of 1.0 and are not suitable for applications where the load will continuously exceed the nameplate rating.

MOTOR REPLACEMENT

In most cases where a replacement motor is to be furnished, it may be selected by copying the nameplate information on the original motor. A new motor identical to the old can then be applied. Inasmuch as motors have standard ratings, dimensions, etc., (by conforming to NEMA standards) a motor of different manufacture than the original can satisfactorily replace the original motor in many cases. However, if the motor is special, which the nameplate reading will usually indicate, direct replacement of a duplicate motor must be made.

Another situation where furnishing a straight identical replacement is not wise is where a premature failure has occurred. Motors may “burn out” for a variety of reasons, but it is always a safe bet that if the motor is under five years old, it has failed due to some misuse. Since any number of

reasons could be responsible for failure, the following chart lists usual conditions that can lead to difficulties with a motor. Should there be any indication of a premature failure, care must be taken to make certain that:

1. The original motor selection was the proper one.
2. The motor was installed correctly, particularly the electrical connections.
3. The power supply was correct.
4. The motor was one of the proper size, (speed and horsepower) to do the job.

If any of these conditions have been violated, the motor was not selected correctly as we have seen in the preceding chapter. Use the following table in pinpointing the difficulty, plus application of the correct motor once the trouble is found, will lead to long service life and complete satisfaction.

Motor Trouble Chart

TROUBLE	CAUSE	WHAT TO DO
Motor Fails to Start	Blown Fuses	Replace fuses at least 125 per cent of nameplate amperes.
	Overload Trips	Check and reset overload in starter.
	Improper current supply	Check to see that power supplied agrees with motor nameplate and load factor.
	Improper line connections	Check connections with diagram supplied with motor.
	Open circuit in winding or starting switch	Indicated by humming sound when switch is closed. Repulsion induction motors may spark at brushes. Check for loose wiring connections; also see if starting switch inside motor is closed.
	Mechanical failure	Check to see if motor and drive turn freely. Check bearings and lubrication.
	Short circuited stator	Indicated by blown fuses. Motor must be rewound.
	Poor stator coil connection	Remove end belts, locate with test lamp.
	Rotor defective	Look for broken bars or end rings.
	Motor may be overloaded	Reduce load.
If 3 phase, one phase may be open	Check lines for open phase.	

TROUBLE	CAUSE	WHAT TO DO
Motor Fails to Start	Defective capacitor	Check for short circuit, grounded or open capacitor, replace if necessary.
	Worn or sticking brushes on repulsion induction motors	Check for wear and correct brush pressure. Clean commutator if dirty.
Motor stalls	Wrong application	Change type or size. Consult manufacturer.
	Overloaded motor	Reduce load.
	Low motor voltage	See that nameplate voltage is maintained.
	Open circuit	Fuses blown, check overload, relay, stator and pushbuttons.
	Incorrect control resistance of wound rotor	Check control sequence. Replace broken resistors. Repair open circuits.
Motor runs and then dies	Power failure	Check for loose connections to line, to fuses and to control.
Motor does not come up to speed	Not applied properly	Consult supplier for proper type.
	Voltage too low at motor terminals because of line drop	Use higher voltage on transformer terminals or reduce load.
	If wound rotor, improper control operation of secondary resistance	Correct secondary control.
	Starting load too high	Check load motor is supposed to carry at start.

Motor Trouble Chart, continued

TROUBLE	CAUSE	WHAT TO DO
Motor does not come up to speed	Broken rotor bars	Look for cracks near the rings. A new rotor may be required as repairs are usually temporary.
	Open primary circuit	Locate fault with testing device and repair.
Motor takes too long to accelerate	Excess loading	Reduce load.
	Poor circuit	Check for high resistance.
	Defective squirrel cage rotor	Replace with new rotor.
	Applied voltage too low	Get power company to increase power tap.
Wrong rotation	Wrong sequence of phases	Reverse connections at motor or at switchboard.
Motor overheats while running under load.	Overload	Reduce load.
	Wrong blowers or air shields, may be clogged with dirt and prevent proper ventilation of motor	Good ventilation is manifest when a continuous stream of air leaves the motor. If it does not after cleaning check manufacturer.
	Motor may have one phase open	Check to make sure that all leads are well connected.
	Grounded coil	Locate and repair.
	Unbalanced terminal voltage	Check for faulty leads, connections and transformers.
	Shorted stator coil	Repair and then check wattmeter reading.
	Faulty connection	Indicated by high resistance.
	High voltage	Check terminals of motor with a voltmeter.
	Low voltage	Check terminals of motor with voltmeter.
	Rotor rubs stator bore	If not poor machining, replace worn bearings.
Motor vibrates after corrections have been made.	Motor misaligned	Realign.
	Weak foundations	Strengthen base.
	Coupling out of balance	Balance coupling.
	Driven equipment unbalanced	Rebalance driven equipment.
	Defective ball bearing	Replace bearing.
	Bearings not in line	Line up properly.
	Balancing weights shifted	Rebalance rotor.
	Wound rotor coils	Rebalance rotor.

TROUBLE	CAUSE	WHAT TO DO
Motor vibrates after corrections have been made	Poly phase motor running single phase	Check for open circuit.
	Excessive end play	Adjust bearing or add washer.
Unbalanced line current on poly phase motors during normal operation	Unequal terminal volts	Check leads and connections.
	Single phase operation	Check for open contacts.
	Poor rotor contacts in control wound rotor resistance	Check control devices.
	Brushes not in proper position	See that brushes are properly seated and shunts in good condition.
Scraping noise	Fan rubbing air shield	Remove interference.
	Fan striking insulation	Clear fan.
	Loose on bed-plate	Tighten holding bolts.
Noisy operation	Air-gap not uniform	Check and correct bracket fits or bearing.
	Rotor unbalance	Rebalance.
Hot bearings general	Bent or sprung shaft	Straighten or replace shaft.
	Excessive belt pull	Decrease belt tension.
	Pulleys too far away	Move pulley closer to motor bearing.
	Pulley dia. too small	Use larger pulleys.
	Misalignment	Correct by realignment of drive.
Hot bearings sleeve	Oil grooving in bearing obstructed by dirt	Remove bracket or pedestal with bearing and clean bearing housing and oil grooves; renew oil.
	Oil too heavy	Use recommended lighter oil.
	Oil too light	Use recommended heavier oil.
	Too much end thrust	Reduce thrust induced by drive, or supply external means to carry thrust.
	Badly worn bearing	Replace bearing.
	Insufficient grease	Maintain proper quantity of grease in bearing.
	Hot bearings ball	Deterioration of grease or lubricant contaminated
	Excess lubricant	Reduce quantity of grease bearing should not be more than 1/2 filled.
	Overloaded bearing	Check alignment, side and end thrust.
	Broken ball or rough races	Replace bearing, first clean housing thoroughly.

GLOSSARY

Alternating Current — the flow of an electrical charge through a conductor that is constantly changing its direction of flow.

Ampere — the unit of measurement of rate of current flow, commonly referred to as an "amp."

Anti-friction bearing — the name given to all bearings in general, but more specifically to the ball or roller-type bearings which are also known as "rolling element" bearings.

Armature — the part of an electrical motor which includes the main current carrying winding. In direct-current machines and in alternating-current commutator machines, the armature winding is connected to the commutator and the armature is the rotating member. In alternating-current machines without commutators, the armature may be either the rotating member or the stationary member.

Axial center — that point on a shaft or other rotating member about which all other points rotate. The axial centerline is a line drawn through and connecting all the axial center points within the member. The line between the north and south poles of the earth about which the earth turns is called its "axis."

Back (of a motor or generator) — the shaft extension and/or in the case of double shaft motors, the end which carries the coupling or driving pulley.

Bar magnet — a rectangular or cylindrically shaped piece of material which has magnetic properties.

Bearing — surface, located in the end bell that supports the shaft and provides for smooth rotation.

Bracket — another name for end shield or end bell.

Breakdown torque — see Torque.

Brush — a conductor serving to maintain electric contact between stationary and moving parts of a motor or other apparatus.

Brushholder — a device which holds the brush in position while insulating the brush from the frame which supports the brushholder.

CW, CCW — clockwise and counterclockwise rotation when viewing motor from the end opposite the shaft.

Capacitance (capacity) — that property of a system of conductors and non-conductors which permits the storage of electricity when potential differences exist between conductors.

Capacitor (Condenser) — a device, the primary purpose of which is to introduce capacitance into an electric circuit. The material which separates the conductors in a capacitor is called the dielectric. Capacitors are usually classified according to this material. For example, there are paper capacitors, air capacitors, oil capacitors and mica capacitors.

Capacitor start motor — a type of single phase induction motor that has a capacitor connected in series with the starting winding.

Capacity — the rated load of a motor, apparatus or device, or the maximum load of which it is capable under existing service conditions.

Centrifugal starting switch — see Starting Switch.

Circuit — an electrical network of conductors that provides one or more closed or complete paths for current.

Coil — one or more turns of wire wound as a unit of an electrical circuit.

Collector rings (Slip rings) — metal rings suitably mounted on an electrical motor and serving, through stationary brushes bearing thereon, to conduct current into or out of the rotating member.

Commutator — a cylindrical ring or disc assembly of conducting members, individually insulated in a supporting structure with an exposed surface for contact with current-collecting brushes and ready for mounting on an armature shaft.

Commutator bars or segments — the metal current-carrying members of a commutator which make contact with the brushes.

Compound wound motor — a direct-current motor which has two separate field windings — one, usually the predominating field, connected in parallel with the armature circuit, and the other connected in series with the armature circuit.

Condenser — see Capacitor.

Conductor — an object so constructed from conducting material that it may be used as a carrier of electrical current.

GLOSSARY, Continued

Current — the flow of an electrical charge through a conductor with the ability to overcome resistance and perform work.

Drive — to turn, operate or cause a motor to do its intended work. Also the package of motor, gearbox, belting, sprockets, etc. necessary to turn, operate or cause a motor to do its work.

Duty — a requirement of service which defines the degree of regularity of the load.

Dynamotor — an electrical motor which combines both motor and generator action in one magnetic field, either with two armatures or with one armature having two separate windings.

Efficiency — the ratio or comparison of useful power output to the power input, expressed in the same units.

Electric motor — a motor which transforms electrical energy into mechanical energy.

Electrically reversible motor — one which can be reversed by changing the external connections, even while the motor is running. If, while the motor is running at full speed in one direction, the connections are suddenly changed for the opposite direction of rotation, the motor will stop, reverse, and come up to full speed in the opposite direction. This type is called the plug reversible motor.

Electromagnet — a magnet in which the field is produced by an electric current. Upon removal of the electrical current it exhibits little or no magnetic influence.

End Bell — see End shield.

End shield — a shield secured to the frame to protect the windings and to support the bearings.

Energy — the ability to do work. Energy cannot be created or destroyed, but it may be transferred among various bodies or changed from one form to another.

Epoxy — a plastic material used to coat the electrical parts of some motors. It is a good insulator.

Field coil — a suitably insulated winding to be mounted on a field pole to magnetize it.

Flexible coupling — a mechanical device used to connect two rotating shafts. Its construction permits a small amount of misalignment between shafts.

Frame — the supporting structure for the stator parts. In a direct-current motor, the frame usually forms a part of the magnetic circuit. It includes the poles only when they form an integral part of it.

Frame size — refers to a set of physical dimensions of motors as established by NEMA.

Frequency — the rate at which alternating current changes its direction of flow, usually expressed in terms of cycles per second or Hertz (Hz).

Front (of a motor or generator) — the end opposite shaft.

Generator — an electrical motor that converts mechanical energy into electrical energy. It may be designed to produce either alternating or direct current.

Hertz or Frequency — The number of times per second that alternating current flows in one direction, reverses, and flows in the other direction. Power companies in the U.S. hold this figure constant at 60 cycles per second.

Horsepower (as applied to motors) — as applied to an electric motor, the horsepower is an index of the amount of work the motor can produce in a period of time. For example: One horsepower equals 33,000 foot pounds of work per minute, that is a one horsepower motor, with suitable gearing and neglecting all losses, can lift 33,000 pounds one foot in a minute, or one pound 33,000 feet in a minute. Assuming 100% efficiency, 746 watts of electrical power will produce one horsepower.

Induction — the production of an electric current in a conductor by a magnetic field in close proximity to it.

Induction motor — one which converts electric power delivered to the primary circuit into mechanical power. The secondary circuit is short-circuited or closed through a suitable circuit.

Insulator — a material or combination of materials which effectively resists the passage of an electric current.

Kilowatt — 1000 watts.

Kilowatt-hour — A unit of work or energy equal to that expended by one kilowatt in an hour.

GLOSSARY, Continued

Laminations — this metal sheets (usually of a silicon-alloy steel) which are stacked together and riveted or otherwise fastened to form the core of an electromagnet. The windings are placed in or around this core.

Locked rotor torque — see Torque.

Magnet — an object having the ability to attract magnetic substances.

Magnetic field — the area surrounding a magnet in which its attraction for magnetic substances is greatest.

Motor-generator set — one or more motors mechanically coupled to one or more generators.

Multi-speed motor — one which can be operated at any one of two or more definite speeds, each being practically independent of the load. For example, a direct-current motor with two armature windings, or an induction motor with windings capable of various pole groupings.

NEMA — National Electrical Manufacturers Association.

Ohm — the unit of electrical resistance to the flow of current.

Ohm's Law — Explains the relationship of amps, volts, and ohms. One amp of electrical current will flow when pushed by one volt against one ohm of resistance.

$$\text{Amps} = \text{volts} / \text{ohms}$$

$$\text{Volts} = \text{amps} \times \text{ohms}$$

$$\text{Ohms} = \text{volts} / \text{amps}$$

Parallel circuit — two or more electrical paths connected so that the current must divide, with a portion of the original current traveling one path while the remainder of the current travels the other path or paths.

Polarity — the quality of attraction or repulsion exhibited by certain materials in an electrical or magnetic system.

Pole pieces (pole shoe) — the cores of the electromagnetic coils mounted in the stator of direct-current motors.

Polyphase — more than one phase, usually three-phase.

Power — the amount of work which can be done in a unit of time. One horsepower is equal to 33,000 foot-pounds of work per minute.

Pull-up torque — see Torque.

Punching — see Laminations.

Rating — the designated limit of operating characteristics of a motor, apparatus or device based on definite conditions. Load, voltage, frequency, and other operating characteristics may be given in the rating.

Resistance — the property of an electric circuit which determines for a given current the rate at which electric energy is converted into heat or radiant energy, and which has a value such that the product of the resistance and the square of the current gives the rate of conversion of energy.

Resistor — a device, the primary purpose of which is to introduce resistance into an electrical circuit.

Rheostat — an adjustable resistor so constructed that its resistance may be changed without opening the circuit in which it may be connected.

Rotor — the rotating part of most alternating-current motors.

Salient pole — that type of field pole which projects toward the armature.

Series circuit — a single electrical path composed of one or more electrical components which are said to be connected in series if all of the current must pass through each component in turn.

Series wound motor — a commutator motor in which the field circuit and armature circuit are connected in series.

Service Factor — number by which the horsepower rating is multiplied to determine the maximum safe load that a motor may be expected to carry continuously.

Shaded pole motor — a special type of single-phase induction motor that utilizes a copper shading coil to provide the necessary displacement for starting.

Shunt wound motor — a direct-current motor in which the field circuit and armature circuit are connected in parallel.

Slip rings — see Collector rings.

Split-phase motor — the most common type of single phase induction motor. Equipped with an auxiliary or starting winding displaced in magnetic position from, and connected in parallel with the main winding.

GLOSSARY, Continued

Squirrel-cage winding — a permanently short-circuited winding, usually uninsulated and chiefly used in induction machines, having its conductors uniformly distributed around the periphery of the motor and joined by continuous end rings.

Starting switch, centrifugal — a centrifugally-operated automatic mechanism usually used in connection with split-phase induction motors to open or disconnect the starting winding after the rotor has attained a predetermined speed, and to close or reconnect it prior to the time the rotor comes to rest.

Starting torque — see Torque.

Static electricity — a phenomenon very much akin to friction, which causes one body to possess an electrical charge which it stores until a path is provided for its escape, an example of this is the small shock one sometimes receives from sliding across an automobile seat and grasping the door handle or some other grounded object.

Stator — that portion of an electrical motor which contains the stationary parts of the magnetic circuit with their associated windings.

Submersible motor — one so constructed that it will operate successfully when submerged in water under specified conditions of pressure and time.

Synchronous motor — one in which the average speed of normal operation is exactly proportional to the frequency of the system to which it is connected.

Terminal — an insulated conductor at which point an electrical component may be connected to another electrical component. A binding post.

Thermal Protection — also called overload. This is a device to take the motor off line to reduce the risk of damage caused by overheating due to voltage, loading or ambient temperature conditions other than normal.

Thrust bearing — one which supports a load that acts along the center line of the supported component. In a motor mounted with its shaft in a vertical position, the weight of the rotor must be supported by a thrust bearing.

Torque — a force which produces or tends to produce rotation. Common units of measurement of torque are pound-feet, pound-inches, ounce-feet, and ounce-inches. A force of one pound applied to the handle of a crank, the center of which is displaced one foot from the center of the shaft, produces a torque of one pound-foot on the shaft, if the force is provided perpendicular to and not along the crank.

Torque, breakdown — the maximum torque which a motor will develop with rated voltage applied to rated frequency, without an abrupt drop in speed.

Torque, locked rotor — the minimum torque which a motor will develop at rest for all angular positions of the rotor, with rated voltage applied to rated frequency. Also called starting torque or breakaway.

Torque, pull up — the minimum external torque developed by an alternating current motor during the period of acceleration from rest to the speed at which breakdown torque occurs. For motors which do not have a definite breakdown torque, the pull-up torque is the minimum torque developed up to rated speed.

U/L — Underwriter's Laboratories, an independent organization that sets safety standards for motors and other electrical equipment.

Universal Motors — see Series motor; one that can be operated on either AC or DC.

Volt — a unit of electrical potential or pressure.

Watt — a unit of electrical power, directly converted to work, the product of voltage and amperage. 746 watts are equal to one horsepower.

Work — the transfer of energy from one object to another, measured in force multiplied by distance, or foot-pounds.

Wound rotor induction motor — one in which the secondary circuit consists of a poly-phase winding or coils whose terminals are either short-circuited or closed through suitable circuits.

QUESTIONS AND ANSWERS

QUESTION:

Why does a 50 degree motor blink lights when it is started?

ANSWER:

Because of the higher starting current required to produce high torque and the increase in allowable operating temperatures, the copper wire which forms the coils of the stator must be of a larger diameter, or of a shorter length. For this reason, the 50 degree rise motor will draw a greater amount of current when starting than will the 40 degree rise motor. The extra current draw could cause a blink in the lighting system.

QUESTION:

What does N.E.M.A. mean?

ANSWER:

N.E.M.A. are the initials of the National Electrical Manufacturers Association. The "NEMA" rating refers to the physical dimensions, electrical characteristics, and/or class of insulation used in building a motor. The practice of building motors to NEMA specifications insures the purchaser of getting what he has paid for. A motor of a certain class will meet the specifications regardless of the manufacturer producing it.

QUESTION:

What does "air over" mean?

ANSWER:

An "air over" motor is the type found on direct connected fans; that is, the motor is located in a stream of moving air. The air stream cools the motor, thus removing the heat without special cooling apparatus.

QUESTION:

What does the duty rating mean, and how is it determined?

ANSWER:

The duty rating is determined by the enclosure, amount of cooling, and the type of insulation used in the motor. This rating is the length of time that the motor may be

operated without causing over-temperatures, or decreases in the normal life-span of the motor. An intermittent duty motor should only be used for an hour or two each day, or more often if it is allowed to cool down between uses. A motor with a continuous duty rating can be run indefinitely at rated load, without overheating.

QUESTION:

Will the new, smaller-frame motors do the same job as the older larger-frame sizes they are intended to replace?

ANSWER:

For economic reasons, present-day motors are produced in a wide variety of characteristics within the same horsepower; therefore, more care should be taken in selecting the correct type of motor. If the correct type motor is chosen, there is no reason why it should not adequately replace the older, larger, more expensive motor of the same horsepower.

QUESTION:

What is the advantage of the NEMA frame size 48 over the NEMA frame size 56?

ANSWER:

All other factors being equal, the 48 frame produces the same horsepower in less space, with less weight.

QUESTION:

Will a 230 volt motor run on 208 volts?

ANSWER:

Yes, however, the performance will be reduced by about 10 to 12 percent, the motor will run at a higher temperature, and there will be no undervoltage reserve.

QUESTION:

How can low voltage "burn out" a motor?

ANSWER:

In order to turn out its rated horsepower, a motor operating at 100% efficiency must draw

QUESTIONS AND ANSWERS, Continued

746 watts for each horsepower it produces. The number of watts a motor requires is determined by multiplying the voltage and the amperage. Thus, it is evident that if the voltage is reduced, the amperage must be increased to maintain the same wattage or horsepower. The increased amperage results in excessive heat and can cause motors to "burn out."

QUESTION:

What are the advantages of a 3-phase motor?

ANSWER:

The main advantage is the lower power rates for 3-phase service. Another advantage is in motor construction since a 3-phase motor needs no centrifugal switch or starting windings. The interaction of the three phases produces the rotating magnetic field within the motor. As a general rule, 3-phase motors require much less starting current and are quite easily reversed by switching any two of the three power supply leads.

QUESTION:

What is meant by single phasing?

ANSWER:

Single phasing is the term used to describe the condition which occurs on 3-phase when a supply line failure causes one of the three power lines to become inoperative. The amps will increase substantially on the other two motor legs and a motor "Burn Out" can occur.

QUESTION:

What is meant by a full "skew" die cast rotor?

ANSWER:

The "skew" of a rotor refers to the amount of angle between the conductor slots and the end face of the rotor laminations. Normally the conductors are in a nearly straight line, but for high torque applications the rotor is skewed, which increases the angle of the conductors. The term "full" refers to the maximum practical amount.

Slight Angle

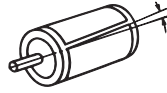

Greater Angle

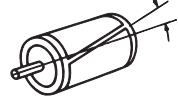

QUESTION:

What can I do the reverse a shaded pole motor?

ANSWER:

It can be reversed by disassembling it, and turning the stator around. This locates the shaded poles on the other side of the main poles, reversing the rotation.

QUESTION:

Why do shaded pole motors get so hot?

ANSWER:

As the magnetic pole shifts to the shaded side of the field magnet, it produces eddy currents within the field magnets, as well as within the rotor. Conventional non-shaded pole motors do not produce as many eddy currents in their fields and consequently do not produce as much heat. This heat is why many shaded pole motors must have air moving over them for proper operation.

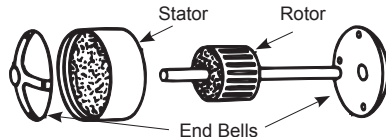

QUESTION:

What can I do to change the rotation of a split phase motor?

ANSWER:

Unless it is a special type of split phase motor, you can reverse the rotation by interchanging a specified pair of connections on the motor terminal board.

QUESTION:

What are "all-angle sleeve bearings"?

ANSWER:

Simply stated, by using them a motor may be mounted at any angle, even vertically.

QUESTIONS AND ANSWERS, Continued

QUESTION:

What advantages other than cost are gained by using sleeve bearings?

ANSWER:

The bearing is not as easily contaminated as the rolling element or ball bearing is. Sleeve bearings are not as likely to become seized if they are contaminated, and they are generally quieter than a normal-quality ball bearing.

QUESTION:

What is meant by 350% or 500% starting torque?

ANSWER:

This means that on start-up, the motor will have 3-1/2 or 5 times the torque (twisting ability) that it has at full speed. This is a very desirable characteristic when heavy loads must be accelerated.

QUESTION:

What is meant by "service factor?"

ANSWER:

The service factor is the amount by which a motor can be overloaded without causing a serious drop off in speed or dangerously high temperatures. If a motor has a service factor of 1.25, then it can be loaded up to 25% greater than its rated horsepower. It is a compensation used to insure continued performance of a motor which must operate under varying load conditions. The service factor can be compared to a safety factor or a safety precaution.

QUESTION:

What is a resilient motor mount, and why do I need one?

ANSWER:

A resilient motor mount is a rubber ring on each end of the motor which cushions the motor base from the vibrations and load shocks which the motor experiences in service. This type of mount is effective in cutting down noise produced by motors which are mounted on or near sounding-board-like

materials, sheet metal, thin plywood, or even air distribution systems.

QUESTION:

When switching from an internal combustion engine to an electric motor, what size electric motor must I use?

ANSWER:

This will depend upon the amount of horsepower that is actually needed to do the job efficiently.

QUESTION:

What is the difference between an "Automatic Thermoguard" and a "Manual Thermoguard?"

ANSWER:

An "Automatic Thermoguard" will automatically click on and off as the motor overheats and then cools. (Never use this type protection on motor tools.) The "Manual Thermoguard" will stop the motor when it overheats but will not start unless the thermoguard button is manually reset. (This type protection for machine tools.)

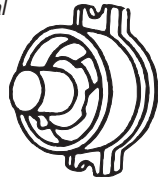

Regal Beloit America, Inc.
1325 Heil Quaker Blvd.
LaVergne, TN 37086
Phone: (866) 887-5216
Fax: (800) 468-2062

